

Stromeyer

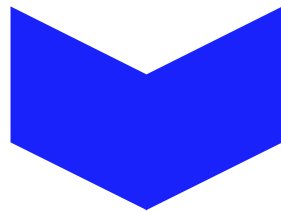

Zelte

Katalog^{cs}

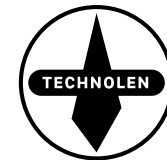

Nepal Varío

Monsun

Fiesta

Gala/Mensa

Elbe

Kabila

Suez

Agadir/Tuareg

Sudan/Gobi

Luxor

Stany kruhového tvaru

Montana

Cosmos

Pascha

Scout 400

Tsavo/Přístřešek

Típi

Dětské típi

Pavillon

–

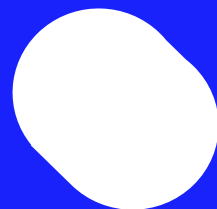
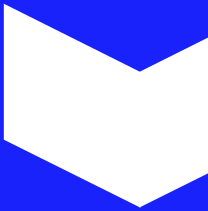
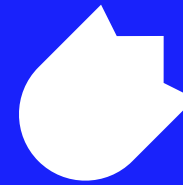

Pavillon

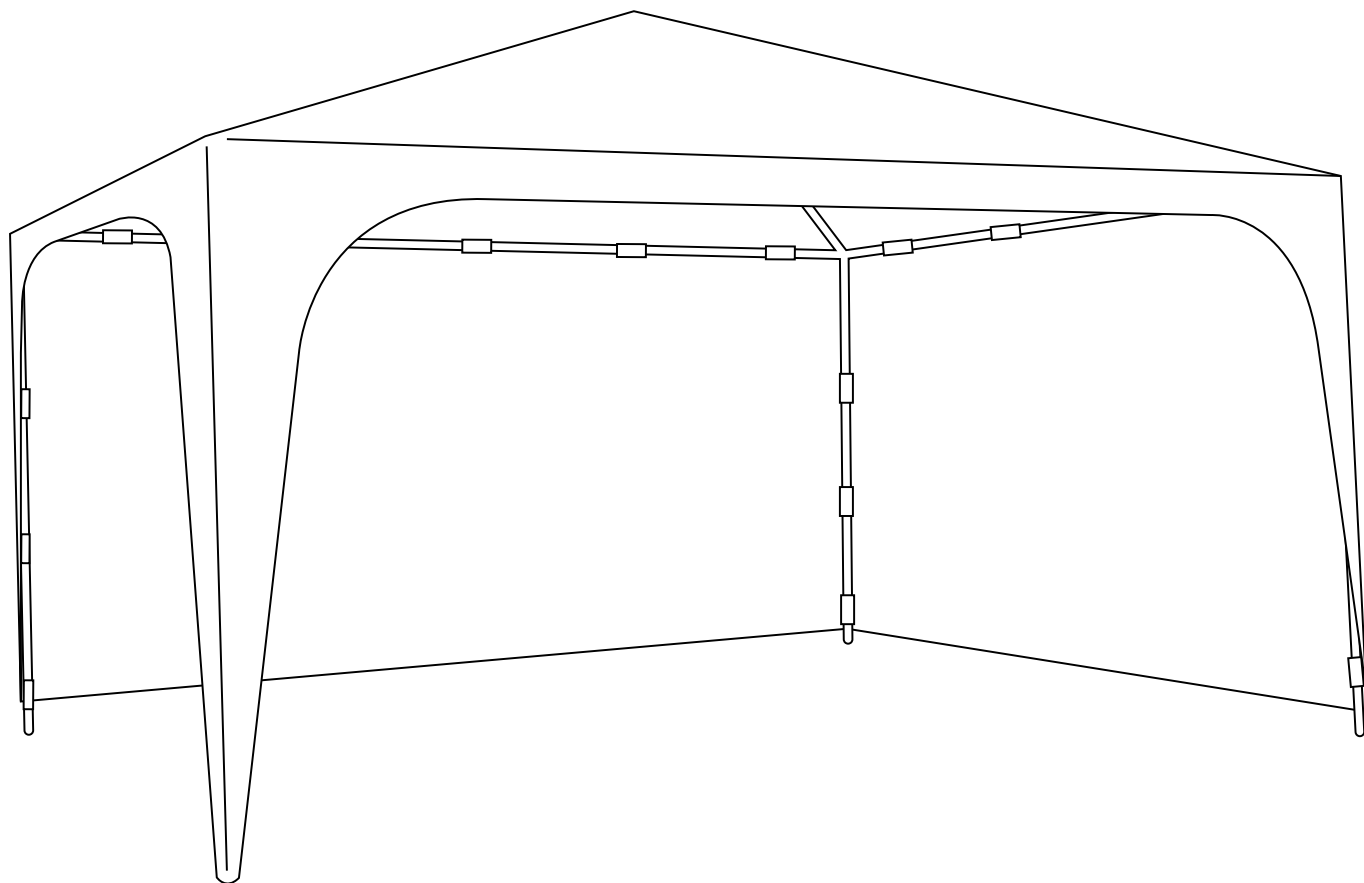

Party stan vyroben z Airtexu. Výhody Airtexu:
odolný proti protrhnutí a plísni, omyvatelný,
lehký, voděodolný a klimaticky odolný.
Pozinkovaná ocelová konstrukce.

Součást dodávky:

boční tyč
střešní tyč

ø 28/1 mm
ø 25/20/1 mm

za příplatek:

bočnice 4 m
bočnice 3 m

hmotnost:

stan 5 kg
konstrukce 20 kg

konstrukce:

Konstrukce z kovových,
pozinkovaných trubek.
Povrch upraven proti korozi.

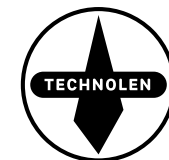

www.technolen.eu
©Technolen t.t.s.r.o.
Česká republika



Pavillon

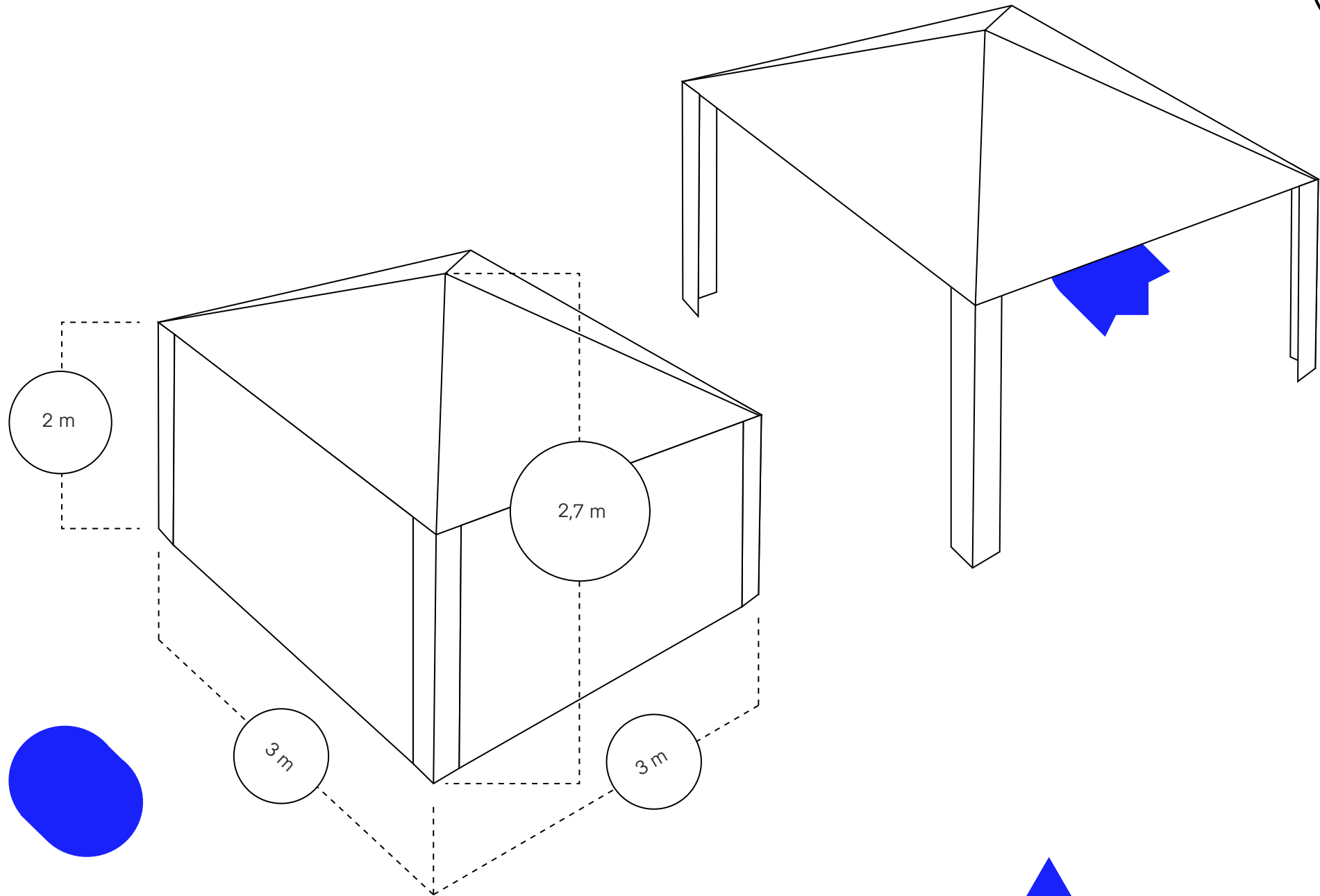

Pavillon



www.technolen.eu
©Technolen t.t.s.r.o.
Česká republika

